

***Global Installation Guide for Suntech
Power Standard Photovoltaic Module***

Version 2025_V3.1_AU_CEC

Wuxi Suntech Power Co., Ltd.

Address: No.9 and No.16 Xinhua Road, Xinwu District Wuxi, China 214028

Customer Service Hot Line: +86 400 8888 009 Fax: +86 510 8534 3321

E-mail: services@suntech-power.com

Or please contact our local representatives, details at www.suntech-power.com

Table of Contents

Introduction	3
Disclaimer	
Laws and Regulations	
Safety Guidelines	4
General Safety	
Electrical Safety	
Handling Safety	
Fire Safety	
Chemical Safety	
Installation Condition	7
Product Identification	9
Module Diagram	
Applicable Product List	
Mechanical Installation	13
Site Selection	
Installation Notice	
Conventional Installation	
Mounting Methods and Mechanical Loads	
Electrical Installation	32
General Installation	
Grounding	
Maintenance	41

** Please read carefully. This document is binding for any warranty case.*

Introduction

First of all, thank you very much for choosing Suntech Power Co., LTD. 's photovoltaic modules (hereinafter referred to as "modules").

This installation manual contains important electrical and mechanical installation information as well as safety information that you must be familiar with, providing important safety instructions for the installation, use and maintenance of solar modules. Users, installation, and maintenance personnel must read this manual carefully and strictly abide by it. Failure to comply with these safety guidelines may result in death, injury or property damage.

The installation and operation of solar modules requires professional skills, and only qualified professionals can perform this work. Please read the safety and installation instructions before operating, installing and maintaining the modules, and keep this manual in a safe place for future reference (maintenance and maintenance), and the installer must inform the end customer (or consumer) of the above matters accordingly.

Disclaimer

Suntech reserves the right to change this installation manual without prior notice. You are advised to visit the Suntech official website <http://www.suntech-power.com> for the latest version installation manual.

This installation manual does not have any warranty meaning, either express or implied. Suntech shall not be liable for any product defect or destruction, personal injury or property damage caused by any operation during the disposal of modules (including but not limited to disassembly/packaging, loading and unloading, handling, transportation, storage, installation, connection, disassembly, operation and maintenance, etc.). Failure by the customer to follow the requirements set forth in this manual in the installation of modules may result in the invalidation of the limited warranty provided to the Customer. Suntech shall not be liable for any infringement of patent rights or rights of third parties caused by the use of modules. At the same time, the suggestions in this manual are tested and verified by practice, and the purpose is to improve the security and stability of the module during installation and operation.

Laws and regulations

Mechanical and electrical installation of photovoltaic modules should refer to the corresponding regulations, including electrical law, construction law and electrical connection requirements. These regulations vary depending on the installation location, and requirements may vary depending on the voltage, current nature (AC or DC) of the installed system. Please contact your local authority for specific terms.

Safety Guidelines

General Safety



Read and understand all safety rules before installing, wiring, operating, or maintaining modules. When

the module is exposed to sunlight or other light sources, direct current (DC) is generated. Whether the modules are connected or not, direct contact with live parts of the modules, such as terminal blocks, may result in injury or death.

Suntech solar modules comply with IEC61215 and IEC61730 standards, meet the requirements of safety Class II, and its application class rating is Class A: The module can be used in public exposure, voltage greater than 50V or power greater than 240W systems.

For your safety, please do not perform installation and maintenance work without safety precautions, including but not limited to fall protection, ladders or stairs, and personal protective equipment.

For your safety, do not install or handle modules in dangerous or harsh environments, including but not limited to strong winds, rain, snow, or dust storms.

Please ensure that you install or handle the integrity of the modules, do not use or install damaged modules, including but not limited to the surface (back) glass is not damaged, the backplane is not broken, the junction box lid is kept closed, the cables and connectors are not broken, and there is no bare metal.

All installation work must be in full compliance with local regulations and corresponding national or international electrical standards.

Electrical Safety



No matter whether the module is connected to the system or not, appropriate protective measures

should be taken when touching the module or entering the power station, such as: insulation tools, safety hats, insulation gloves, safety belts and insulation shoes, etc., to avoid direct contact with 30V or higher DC voltage, 30V or higher DC voltage is potentially fatal.

The module has no switch and can only be stopped by removing the module from light (for example, by shielding it with cloth, cardboard, or a completely opaque material).

In some cases, the open circuit voltage or short circuit current generated by the module exceeds the corresponding values tested under its standard test conditions (STC: irradiance 1000W/m², module temperature 25 ° C, atmospheric mass 1.5). Therefore, when calculating the module rated voltage, rated current, safety fuse and control specifications connected to the PV output, it should be multiplied by a reasonable factor, and the safety factor reference value is 1.25. The appropriate coefficients as well as the electrical design and calculation of the system need to be determined by a qualified electrical engineer based on the relevant design regulations and system simulation results.

Use dry tools to install or maintain modules in dry conditions. Do not touch modules when they are wet unless wearing appropriate anti-electric shock equipment; When cleaning modules, follow the instructions in this manual.

To avoid the risk of arcing and electric shock, do not disconnect the module from any electrical appliance while in operation. A faulty connection can also cause arcing and electric shocks. Connectors must be kept dry and clean to ensure they are in good working order. Do not insert other metal objects into the connector or make electrical connections in any other way.

When a grounding alarm occurs in the system, wear protective devices and disconnect the system from the faulty module under safe conditions. Do not touch other parts of the module to avoid potential electric shock.

Only use compatible connectors to connect modules or connect modules to other devices. Removing the connector will result in loss of product warranty.

Handling Safety



To ensure the safety of modules during transportation and storage, unpack modules after they arrive at the installation site.

When stacking modules, strictly comply with the upper limit on the number of layers printed on the packing case. Do not stack more than two layers of vertical packages on the short side, but allow stacking of vertical packages on the long side.

During the storage process, protect the package from damage, and store the module in a dry and ventilated environment to avoid direct sunlight and humidity. If the modules are stored in an uncontrolled environment, they shall not be stored for more than 3 months and additional measures shall be taken to protect the modules from moisture or sunlight.

If the modules will not be installed within a short time after unpacking, the remaining modules should be placed horizontally on the tray in the form of border alignment, and the number of stacked pieces should not exceed 12. This temporary storage method does not allow secondary transfer; if a secondary transfer is required, place scattered modules of the same version together according to the number and placement of the whole package before unpacking, and secure the modules in the manner before unpacking with a packing tape (recommended pulling force: 2100N). Finally, apply moisture-proof and dustproof measures before the secondary transfer.

When unpacking the modules, please follow the Suntech official packing and unpacking instructions.

Do not wear metal rings, watches, earrings, nose rings, lip rings or other metal materials when installing or repairing the photovoltaic system.



In any case, do not carry a module by lifting its wires and junction boxes. You can hold the frame of the module while carrying it.

Do not deform or bend modules due to factors other than their own weight during transportation or installation.

Do not stand, sit, trample, walk or jump on the assembly.

Do not apply excessive loads to modules or twist modules.

Do not disassemble or remove any part of the assembly, including but not limited to nameplates, labels, junction boxes, connectors, frames, etc.

Do not paint or apply any other adhesive to the surface of the module.

Drilling in the frame of the module is prohibited, which will result in a reduced load resistance of the module and will lose the limited warranty of the module.

Do not damage or scratch the front or back of the module, which may affect the safety of the module. If the front or back of the module is damaged, do not use the module.

Do not drop or stack heavy objects, tools or sharp objects equal to modules.

Do not pull hard, scratch or bend the cable too much, otherwise the insulated part of the cable will be damaged, resulting in leakage or electric shock. (The minimum bending radius of a cable is 43mm.)

Do not insert any conductive material into the connector of the module.

Do not use mirrors or other magnifying glasses to artificially focus sunlight on the modules.

It is prohibited to lift or fix modules by supporting their front glass or back sheet. Improper supporting may cause module cracking, damage and personal injury. Always handle modules by their frames only.

Do not repair modules by yourself.

Do not use damaged modules.

Do not expose modules or junction box connectors to unauthorized chemical substances. Including but not limited to gasoline, white flower oil, activating oil, mold temperature oil, motor oil (e.g. KV46), lubricating grease (e.g. Molykote EM series), lubricating oil, rust prevention oil, stamping oil, butter, diesel oil, cooking oil, acetone, alcohol, air essence, bone-setting water, Tena water, release agent (e.g. Pelicoat) S-6, etc.), board adhesives and potting adhesives that can produce oxime gas (such as KE200, CX-200, Chemlok, etc.), TBP (plasticizer), cleaning agent, herbicide, paint remover, binder, rust inhibitor, scale remover, emulsifier, cutting oil and cosmetics, etc. For more information, please contact Suntech Technical Support.

Fire Safety



Before installing modules, consult local laws and regulations and comply with the installation or building fire safety guidelines and requirements. Suntech modules have passed the UL 790 (Standard Test Methods for Fire Resistance of Roof Covering Materials) fire rating test, with an exact fire rating of Class C, and also comply with the IEC 61730 standard fire rating requirements.

During roof installation, the roof must be covered with a layer of fire-resistant material suitable for this grade, and adequate ventilation between the back of the module and the mounting surface must be ensured. The minimum distance between the modules and the roof surface is 10 cm.

The different structure and installation methods of the roof will affect the fire safety performance of the building, and if the installation is not appropriate, it may cause fire.

The fire rating is valid only if the module is installed in the manner required by the installation instructions. For fire safety requirements and guidance for buildings and structures and support systems at the project site, please consult the relevant local agencies and support suppliers.

Use appropriate modules such as fuses, circuit breakers, and ground connectors according to local regulations.

Do not install or use modules near open flames or flammable or explosive objects.

Do not use water to extinguish the fire when the power supply is not disconnected.

Chemical Safety

In some coastal installation scenarios, the modules of corrosion protection products have certain properties that may pose a safety risk to the personnel installing the modules. Suntech urges anyone involved in or close to corrosion protection solutions to obtain a Material Safety Data Sheet (MSDS) for the selected corrosion protection application.

Whether you choose a fluorocarbon solution or a butyl tape product, read this user manual carefully and strictly follow it. Special protective equipment may be required before or during operation. Please refer to the Material safety data sheet of the product.

Installation Condition

Place and Environment

Modules are suitable for general climatic conditions, i.e. refer to IEC 60721-2-1-Classification of Environmental Conditions Part 2-1: Environmental Conditions occurring in nature. Temperature and humidity.

It is recommended that modules be installed in an environment where the operating temperature ranges from -40 °C to 40 °C. Regardless of the installation conditions, the 98th percentile of the module operating temperature is recommended to be at or below 70 °C. If it is necessary for the 98th percentile of the operating temperature to reach 80 °C, a BOM that meets IEC 63126 Class 1 should be selected.

The module is not suitable for space environment, and it is recommended that the altitude of the module be installed is not more than 2000 meters.

The modules need to be installed in an area where there is no shadow all year round. Ensure that the installation site of the modules is free of obstacles that may block light. If the whole or part of the module is obscured, it will not perform under ideal conditions and result in lower power output. Persistent or frequent shading of the module from sunlight will damage the module and void the warranty.

For the double-sided power generation module, under the premise of ensuring the front power generation, the obstruction on the back side of the double-sided photovoltaic module is avoided as far as possible, so that the power generation on the back side is maximized.

Ensure that the wind or snow pressure on the module after installation does not exceed the maximum allowable load.

If the module is installed in an area with frequent lightning activity, it must be protected against lightning strikes.

Do not install modules where there is a risk of flooding or constant exposure to sprinklers or fountains.

In harsh environments such as heavy snow, extreme cold, strong winds, or near water, salt spray on islands or deserts, take appropriate protective measures to ensure reliable and safe installation of modules.

Modules can be installed on the roof, but need to be evaluated by a construction expert or engineer, have a formal complete structural analysis results, and be proven to be able to withstand additional system support pressures, including the weight of the photovoltaic module itself.

Do not install the module in an environment with highly corrosive substances such as salt, salt spray, salt water, active chemical vapors, acid rain, or any other substance that will corrode the module, affect the safety or performance of the module.

Dip Angle and Orientation

The inclination of the module refers to the Angle between the surface of the module and the ground plane, and the power output is maximum when the module is facing the sun.

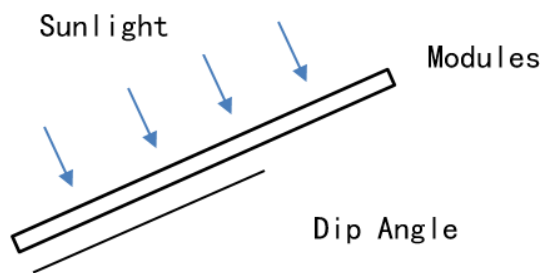

Different projects choose the appropriate installation Angle according to local conditions, Suntech recommends that under the site conditions, follow the principle of maximizing annual power generation as much as possible to install the Angle, so as to reduce the number of module cleaning, the specific installation Angle can be based on the design standards implemented by the project or consult professional solar installers and system integrators. For installation at a small Angle (Suntech recommends that the installation Angle be no less than 10°), it is recommended to increase the cleaning frequency according to the actual situation to avoid long-term

accumulation of large amounts of dust, which will affect the appearance and performance of the modules.

When installing photovoltaic modules in the northern Hemisphere, the optimal installation direction of the module is to face south; When installing photovoltaic modules in the Southern Hemisphere, the optimal installation direction of the module is to face north.

Serial connected PV modules should be installed in the same orientation and Angle. If the orientation or Angle is different, there may be output power loss caused by mismatch due to the different amount of solar radiation received by each module.

Product Identification

Module Diagram

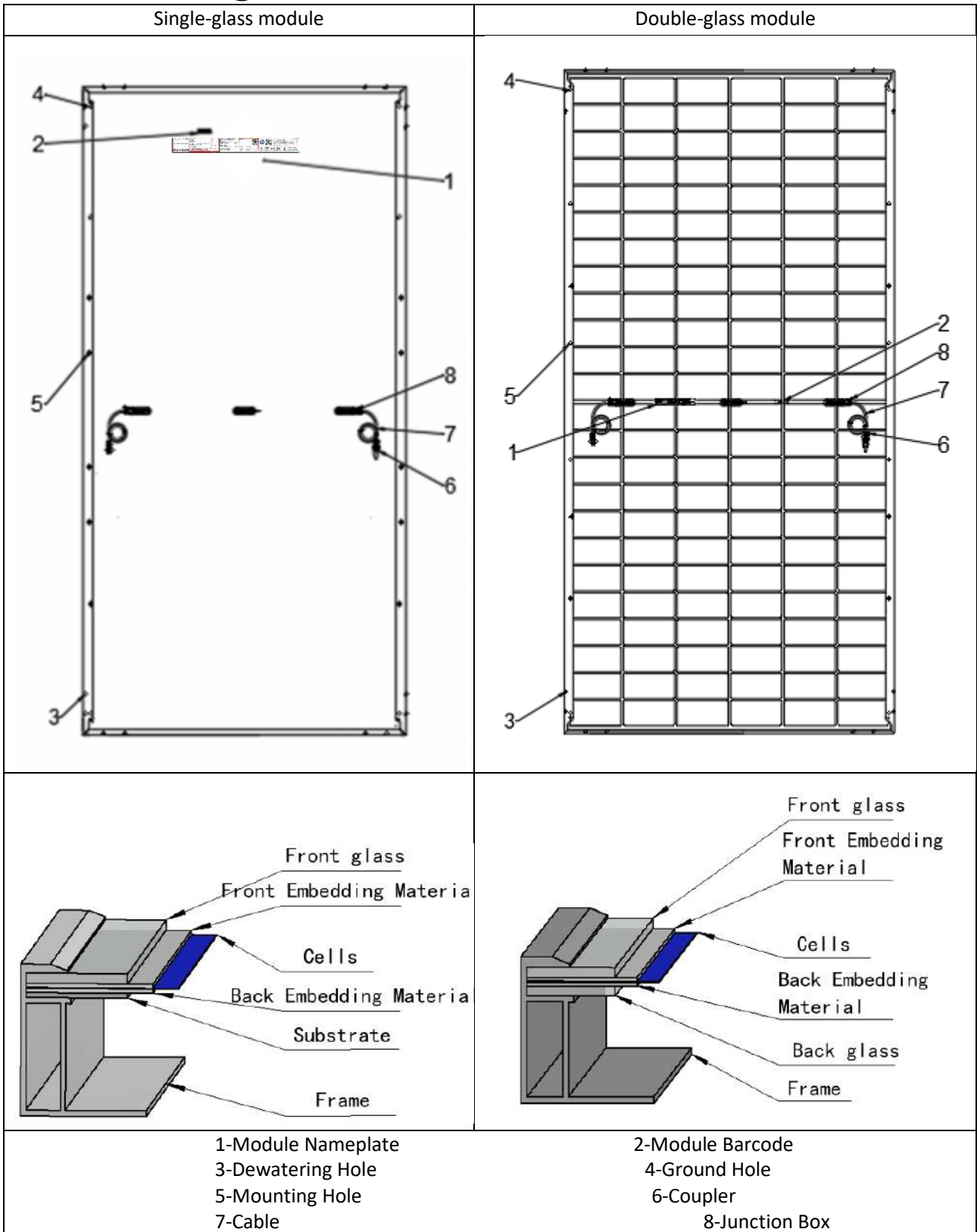

Each module has three labels providing the following information:

1. Nameplate: describes model number; electrical properties like rated power, rated current, rated voltage, open circuit voltage, short circuit current etc., mechanical properties like weight, dimensions etc., certification information, company information as well as product origin.

2. Barcode: each individual module has a unique serial number. The serial number has 18 digits. The 15th and the 16th digits are the week code, and the 17th and the 18th digits are the year code. For example, STP xxxxxxxxxxxxxx2414 means the module was assembled and tested in the 24th week of 2014. Each module has only one bar code. It is permanently attached to the interior of the module and is visible from the top front of the module. This bar code is inserted prior to laminating.



**Typical serial number barcode label*

3. Sorting label: Consists of barcode and current sorting information. Modules are sorted out and categorized according to each of their output current, which is demonstrated with a symbol "I_x" on the right. "x" refers to 1 or 2 as modules usually grouped in two classes. In order to get optimal performance out of a string, it is recommended to connect modules with the same "I_x" class (for example only I₂ modules). The barcode on the left is the same with aforementioned "Barcode" section.



**Sorting label*

Note: Do not remove any labels. Removing any of these will void the Suntech warranty.

Applicable product list

Suntech Module Type	Module Dimension (Length × Width × Thickness) (Length and width tolerance ±2mm)
C54 single-glass series	STPXXXS-C54/Umh
	STPXXXS-C54/Umhm
	STPXXXS-C54/Umhb
	STPXXXS-C54/Nsh
	STPXXXS-C54/Nshm
	STPXXXS-C54/Nshb
C54 double-glass series	STPXXXS-C54/Pmh+
	STPXXXS-C54/Nsh+
	STPXXXS-C54/Nshm+
	STPXXXS-C54/Nshb+
	STPXXXS-C54/Nshkm+
	STPXXXS-C54/Nshtb+
C60 single-glass series	STPXXXS-C60-Nkh
C72 single-glass series	STPXXXS-C72/Vmh
	STPXXXS-C72/Vmhm
	STPXXXS-C72/Vmhb
	STPXXXS-C72/Nsh
	STPXXXS-C72/Nshm
	STPXXXS-C72/Nshb
C72 double-glass series	STPXXXS-C72/Pmh+
	STPXXXS-C72/Nsh+
	STPXXXS-C72/Nshm+
	STPXXXS-C72/Nshb+
C78 single-glass series	STPXXXS-C78/Vmh
	STPXXXS-C78/Vmhm
	STPXXXS-C78/Vmhb
	STPXXXS-C78/Nsh
	STPXXXS-C78/Nshm
	STPXXXS-C78/Nshb
C78 double-glass series	STPXXXS-C78/Pmh+
	STPXXXS-C78/Nsh+
	STPXXXS-C78/Nshm+
	STPXXXS-C78/Nshb+

Suntech Module Type		Module Dimension (Length × Width × Thickness) (Length and width tolerance ±2mm)
D66 single-glass series	STPXXXS-D66/Wmh	2384mm × 1303mm × 33(35)mm
	STPXXXS-D66/Wmhm	
	STPXXXS-D66/Wmhb	
	STPXXXS-D66/Nsh	
	STPXXXS-D66/Nfb	
D66 double-glass series	STPXXXS-D66/Pmh+	2384mm × 1303mm × 33(35)mm
	STPXXXS-D66-Nsh+	
D60 single-glass series	STPXXXS-D60/Wmh	2172mm × 1303mm × 33(35)mm
	STPXXXS-D60/Wmhm	
	STPXXXS-D60/Wmhb	
D60 double-glass series	STPXXXS-D60/Pmh+	2172mm × 1303mm × 33(35)mm

Suntech Module Type		Module Dimension (Length × Width × Thickness) (Length and width tolerance ±2mm)
H48 single-glass series	STPXXXS-H48-Nkh	1762mm × 1134mm × 30mm
	STPXXXS-H48-Nfb	
H48 double-glass series	STPXXXS-H48-Nsh+	1762mm × 1134mm × 30mm
	STPXXXS-H48-Nkh+	
	STPXXXS-H48-Nth+	
	STPXXXS-H48-Nfb+	
	STPXXXS-H48-Nsfb+	
H54 double-glass series	STPXXXS-H54-Nsh+	1961mm × 1134mm × 30mm
	STPXXXS-H54-Nth+	
	STPXXXS-H54-Nfb+	
	STPXXXS-H54-Nkh+	
H66 single-glass series	STPXXXS-H66-Nkh	2382mm × 1134mm × 30mm
	STPXXXS-H66-Nfb	
H66 double-glass series	STPXXXS-H66-Nsh+	2382mm × 1134mm × 30mm

If you have previously installed Suntech modules that are not on the list and need inquiries, please contact Suntech Technical team.

Mechanical Installation

Installation Notice

Please check the optical deviation carefully before installation. Any optical deviation that occurs after the system has been installed may void the warranty. Once incurred, any potential costs such as labor costs, materials costs, documentation costs, personnel security and costs associated with optical deviation elimination are not covered by Suntech's warranty.

The support structure of the module must be made of durable, rust-resistant and UV-resistant materials. Use tested and certified support structures.

In areas where there is a lot of snow in winter, choose the right support system height so that the lowest edge of the module is not covered by snow at any time. In addition, make sure that the lowest part of the module is placed at a sufficient height so that plants and trees do not block the sun.

For ground-mounted systems, Suntech recommends a minimum distance of at least 60 cm from the base of the module.

Modules must be securely placed on support structures. If a clamp is used for installation, the recommended maximum pressure per clamp is 20Mpa to prevent damage to the module bracket. Please follow the clamp system supplier's instructions.

Provide adequate ventilation to the base of the assembly as required by your local regulations. A minimum distance of 10 cm is usually recommended between the roof plane and the support of the modules.

Always follow instructions and safety precautions for module mounts.

Before installing modules on the roof, ensure that the roof is properly constructed. In addition, any roof where modules need to be installed must be sealed to prevent water leakage.

Dust accumulation on the surface of the module can damage the performance of the module. The tilt Angle of the installation module should not be less than 10°, so that dust will be washed by rain. The tilt Angle over the widget requires more frequent cleaning.

The distance between the two modules is recommended to be at least 1 cm to prevent damage caused by thermal expansion.

When installing modules on columns, the column and module support structure must be selected to withstand local wind and snow loads.

Ensure that the modules are not subjected to wind and snow loads exceeding the maximum allowable load, and are not subjected to the thermal expansion generating force of the support structure. Do not allow modules to overlap or exceed the roof. Refer to the following installation methods for details.

Ensure that modules do not appear behind buildings or trees, and that permanent occlusion is prohibited. Regular regular maintenance management should be carried out to keep modules clean and measures taken to avoid permanent blockage caused by dust or debris. Temporary occlusion can also cause a decrease in the power generation of the module.

Connect the appropriate number of modules according to the voltage specification of the inverter used by the system. Even under the worst local temperature conditions, the voltage generated by the connected modules shall not be higher than the voltage value indicated on the nameplate of the system.

Conventional Installation

Modules can be installed on the support using mounting holes, clamps, or chutes. The recommended torque is 16 Nm - 20 Nm for M8 coarse thread and 10 Nm - 14 Nm for M6 coarse thread. The yield strength of bolts and nuts is greater than or equal to 450MPa. Modules must be installed according to the following sample. Failure to install modules according to the following instructions will void the warranty.

Recommended accessories for module installation are shown in the following table:

Attachment	Type specification		Material	Remark
Bolt	M8 (Recommended full thread)	M6 (Recommended full thread)	Hot dip galvanized or stainless steel	Fastener material selection according to the local environment, it is recommended to use stainless steel material
Plain washer	2 pieces, thickness $\geq 1.5\text{mm}$ and outer diameter 16mm	2 pieces, thickness $\geq 1.5\text{mm}$ and outer diameter 12-18mm	Hot dip galvanized or stainless steel	
Spring washer	8	6	Hot dip galvanized or stainless steel	
Nut	M8	M6	Hot dip galvanized or stainless steel	

Under the action of gravity, the glass surface of the module will produce different degrees of subsidence. When storing, transporting, and mounting modules, applying additional forces to the surface of the modules may cause the module shape variable to increase. In the absence of wind load, snow load and other external forces, the maximum allowable shape variable of the module center $\Delta L=20\text{mm}$.

This is an elastic deformation, the module can be restored after removing or removing the load, will not produce hidden cracks and power attenuation of the battery, but it is easy to produce ash, need to improve the frequency of cleaning the ash on the surface of the module.

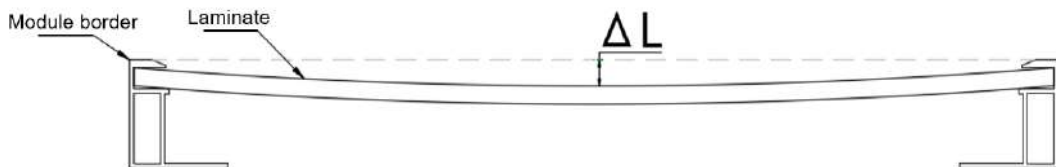

The photovoltaic module tracks the mounting mode of the bracket, and the maximum variable allowed at the edge of the module $\Delta L=25\text{mm}$.

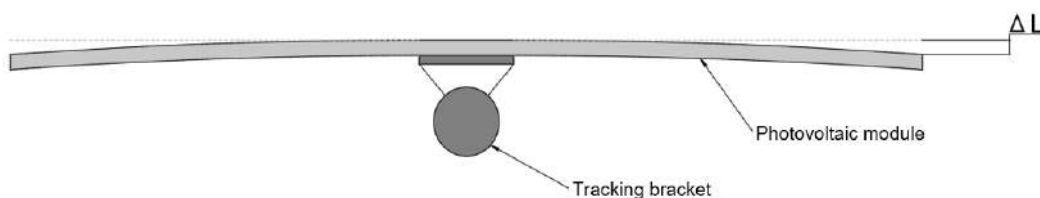

After evaluation, the appearance caused by self-weight or other loads is not identified as a defect and is not covered by the warranty.

Bolt mounting

The assembly shall be bolted to the support structure using the mounting holes specified by Suntech on the back of the frame.

Each module shall be fastened with a minimum of four fixing points, distributed in pairs on two opposite sides. According to the following diagram, flat washers and spring washers must be used, and the size and thickness of the washers should not be lower than the standard size stipulated by the national standard.

The appropriate bolt length should be selected according to the actual module frame height.

Suntech PV modules have mounting holes matching M6 and M8 bolts. The corresponding holes are shown in the following table:

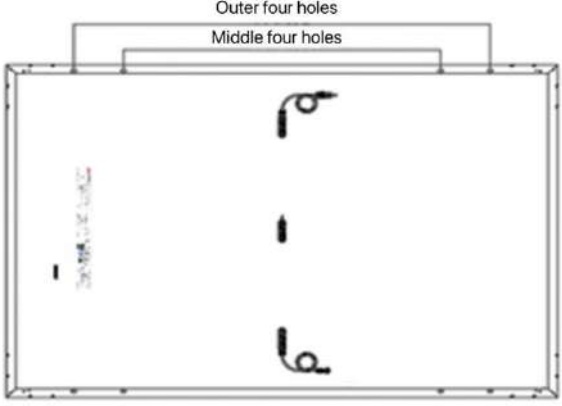
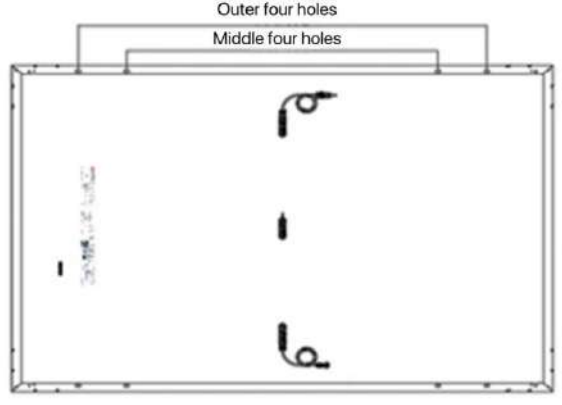
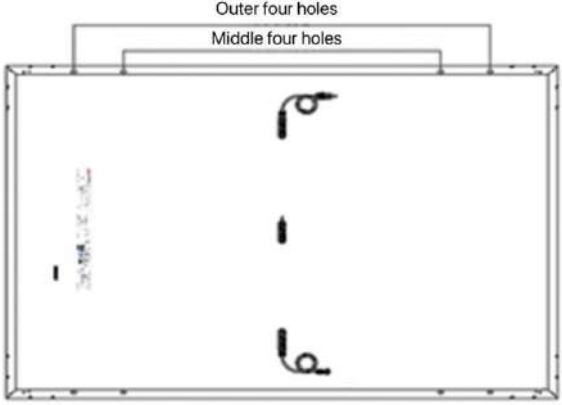
Module type	Installation diagram	Remark
H48 series		<p>The outer four holes (hole spacing 1100mm) are used for conventional bolt mounting, matching M8 bolts.</p>
C54 series		<p>Either the outer four holes (hole spacing 1400mm) or the middle four holes (hole spacing 1150mm) are used for conventional bolt mounting, matching M8 bolts.</p>
C60 series H54 series		<p>Either the outer four holes (hole spacing 1300mm) or the middle four holes (hole spacing 990mm) are used for conventional bolt mounting, matching M8 bolts.</p>

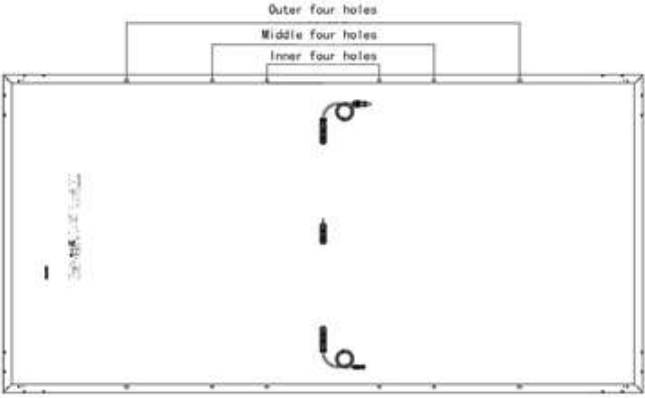
<p>C72 series H66 series</p>		<p>The outer four holes (hole spacing 1400mm) are used for conventional bolt mounting, matching M8 bolts</p> <p>Either the middle four holes (790mm spacing) or the inner four holes (400mm spacing) are used mounting on the tracking support, matching M6 bolts.</p>
----------------------------------	--	--

Suntech PV module bolt installation method is shown in the following figure:

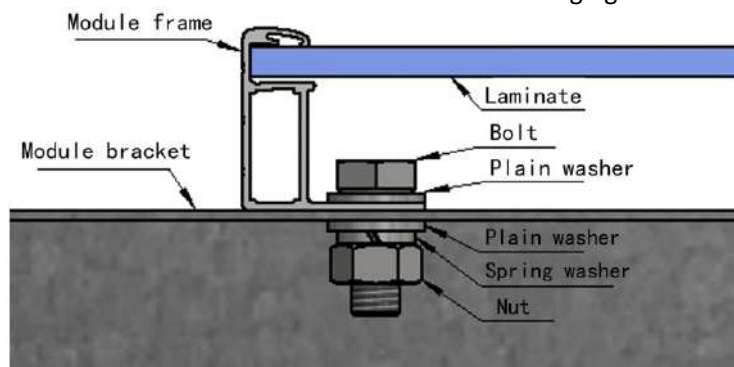

Clamp installation

The clamp installation method varies according to the structure of the mounting bracket. Follow the installation guide recommended by the installation system supplier.

Each module shall be fastened with a minimum of four fixing points, distributed in pairs on two opposite sides. The clamp needs to be arranged symmetrically. The clamp shall be installed within the scope authorized by Suntech. The inside side of the clamp and the side of the photovoltaic module should be completely fitted.

In any clamp installation mode, the clamp must not touch the glass or deform the frame of the bracket or module. Do not damage the coating on the frame surface during installation.

Module jigs and chutes should be avoided to form shadows overshadowing the solar cells. Avoid sealing or covering the drain holes on the assembly brackets.

Special clamp should be used for installation, it is recommended to use 6005-T5 aluminum alloy clamp. M8 bolt and nut are used for this clamping method. Tightening torques should be within 18~24 N•m for M8 coarse thread bolts, depending on the bolt class. For the bolt grade, the technical guideline from the fastener suppliers should be followed. The size of the clamp is shown in the figure below, the length and width of the clamp are represented by a and b, the height of the clamp is represented by c, the overlap width between the clamp and the frame is represented by d, and the thickness of the clamp is represented by e. The clamp should be installed in such a manner that no shadows are cast on the photovoltaic modules. Drainage holes must not be blocked by the clamp. The overlap width d between the clamp and the assembly frame shall be at least 10mm (the clamp cross-section may be changed on the premise of ensuring the reliable installation of the photovoltaic modules).

(For clamp installation that does not meet the above requirements, please contact Suntech technical team for evaluation)

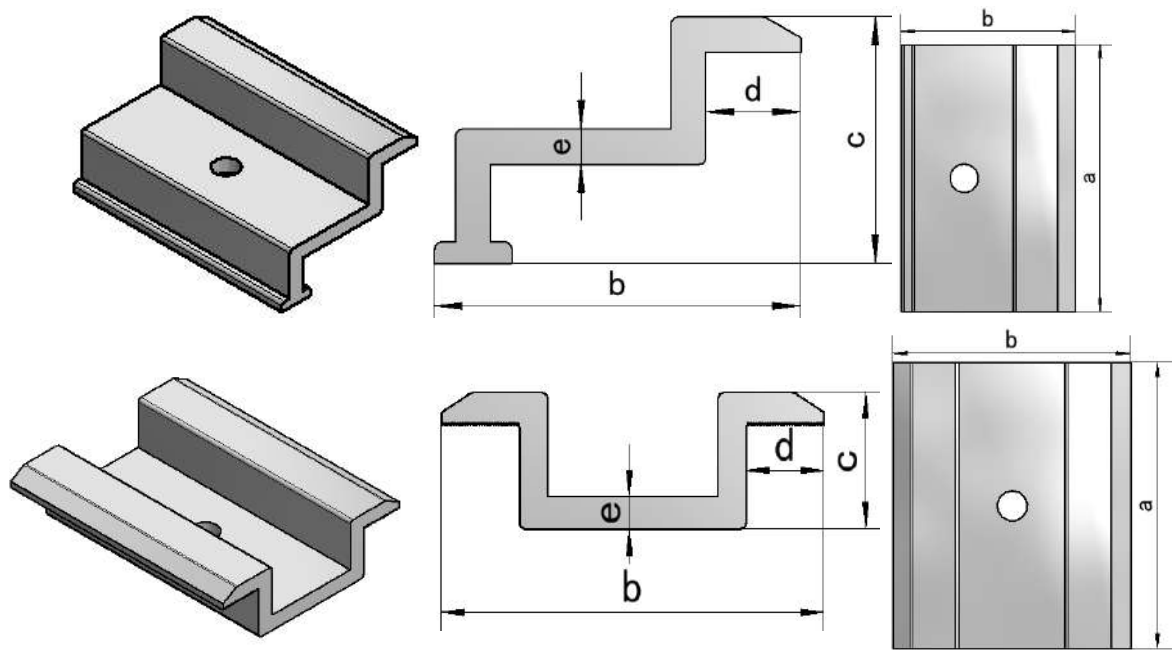

For customers with high load requirements, it is recommended to use a hook-shaped toothed press block that matches the module frame, and the thickness of the press block is at least 4mm. The specific size of the press block is shown below:

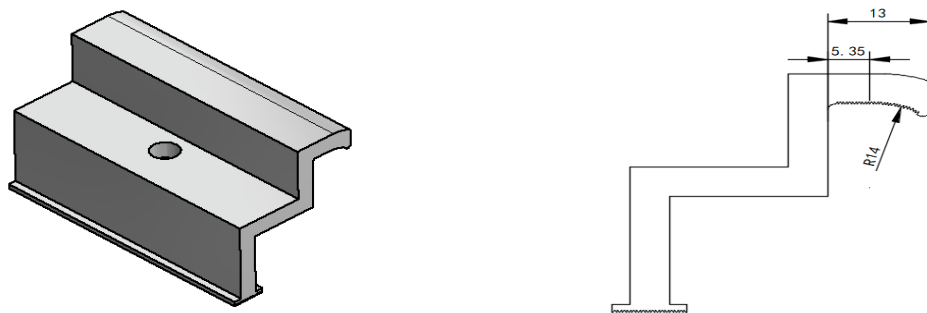

Suntech PV module clamp installation method see the following figure:

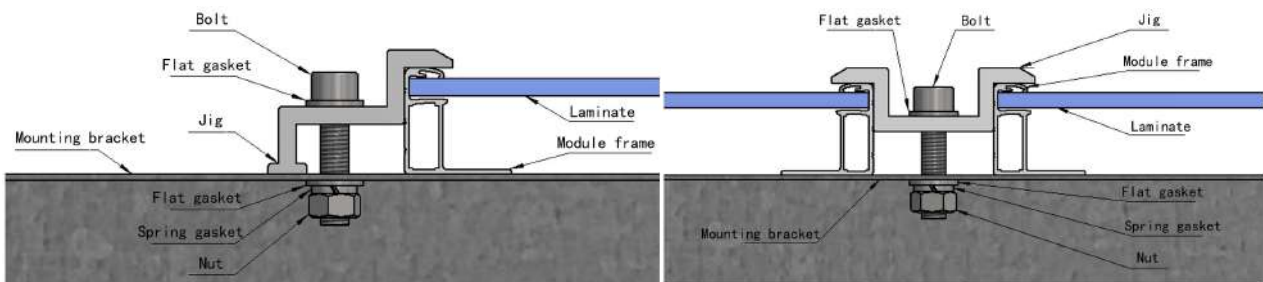

For structures where the mounting rail is parallel to the frame, overlap the assembly frame mounting surface and the rail by at least 20mm.

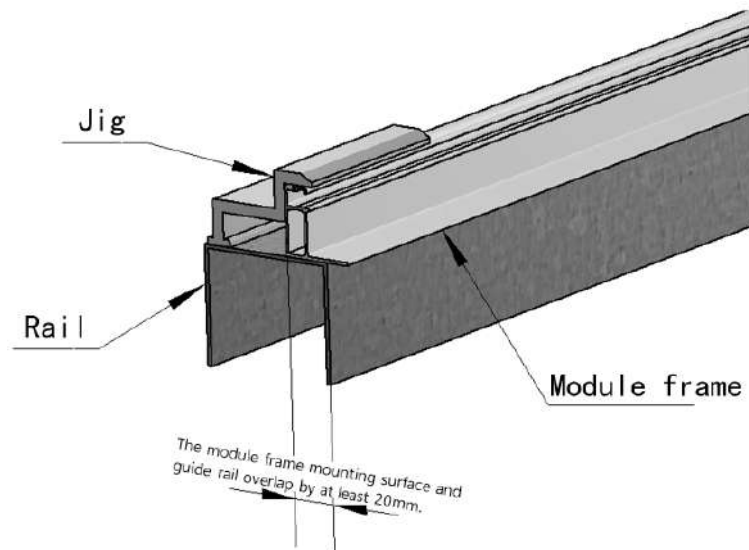

Modules can be mounted horizontally and vertically.

The assembly must be securely attached to the support in order to withstand the corresponding positive and negative pressure. The installer must be responsible for ensuring that the clamps used to secure the modules are of sufficient strength.

Mounting Methods and Mechanical Loads

Select the appropriate mounting method based on the load requirements (see below for more details).

The loads described in this manual are test loads. The design load of the project needs to depend on the project location, local climate, support structure and relevant specifications. Support suppliers and professional engineers are responsible for determining the design load. According to the installation requirements of IEC 61215/61730, a safety factor of 1.5 times should be taken into account when calculating the corresponding maximum design load. For more detailed information, please follow the local laws and regulations and the instructions of the structural engineer.

$$\text{Test load} = 1.5 (\text{safety factor}) * \text{Design load}$$

The figure in the table below is for reference only, Suntech does not provide any installation related parts, installers or trained professionals must be responsible for the design of the PV system, installation and local load value calculation and safety responsibilities.

For each mounting method, modules can be mounted vertically or horizontally.

Conventional installation

Note: The loading values listed below are based on Suntech's internal assessment.

Outer four-hole bolt mounting (beam perpendicular to long frame)



Module type	Maximum test mechanical load (Pa)
C54 single-glass series	+5400/-2400
C54 double-glass series	+5400/-2400
C60 double-glass series	+5400/-2400
C72 single-glass series	+5400/-2400
C72 double-glass series	+5400/-2400
C78 single-glass series	+5400/-2400
C78 double-glass series	+5400/-2400
D60 single-glass series	+5400/-2400
D60 double-glass series	+5400/-2400
D66 single-glass series	+5400/-2400
D66 double-glass series	+5400/-2400
H48 single-glass series	+5400/-2400
H48 double-glass series	+5400/-2400
H54 double-glass series	+5400/-2400
H66 single-glass series	+5400/-2400
H66 double-glass series	+5400/-2400

Middle four-hole bolt mounting (beam perpendicular to long frame)

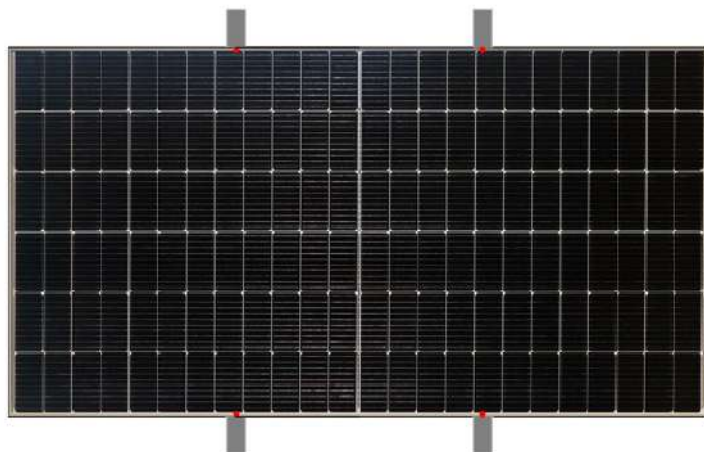

Module type	Maximum test mechanical load (Pa)
C54 single-glass series	+3800/-2400
C54 double-glass series	+3800/-2400
C60 double-glass series	+3800/-2400
C72 single-glass series	/
C72 double-glass series	/
C78 single-glass series	/
C78 double-glass series	/
D60 single-glass series	/
D60 double-glass series	/
D66 single-glass series	/
D66 double-glass series	/
H48 single-glass series	+3800/-2400
H48 double-glass series	/
H54 double-glass series	/
H66 single-glass series	/
H66 double-glass series	/

Outer four-hole bolt mounting (beam parallel to long frame)

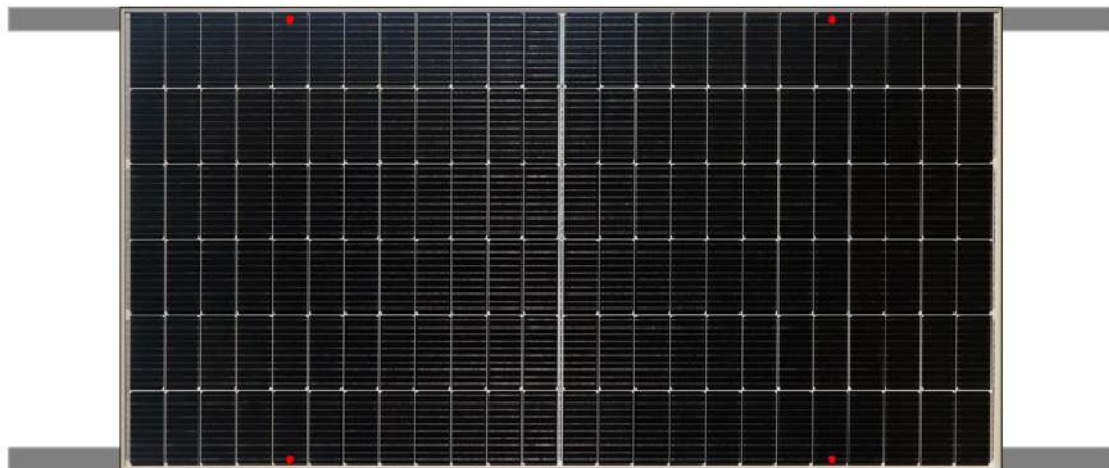

Module type	Maximum test mechanical load (Pa)
C54 single-glass series	+4000/-2400
C54 double-glass series	+4000/-2400
C60 double-glass series	+4000/-2400
C72 single-glass series	+3600/-2400
C72 double-glass series	+3600/-2400
C78 single-glass series	/
C78 double-glass series	/
D60 single-glass series	+3600/-2400
D60 double-glass series	+3600/-2400
D66 single-glass series	+3600/-2400
D66 double-glass series	+3600/-2400
H48 single-glass series	+4000/-2400
H48 double-glass series	+4000/-2400
H54 double-glass series	/
H66 single-glass series	+3600/-2400
H66 double-glass series	+3600/-2400

Long frame clamp mounting (beam perpendicular to long frame)



Module type	L(mm)	A(mm)	Maximum test mechanical load (Pa)
C54 single-glass series	200	200	+5400/-2400
C54 double-glass series	200	200	+5400/-2400
C60 double-glass series	200	200	+5400/-2400
C72 single-glass series	400	250	+5400/-2400
C72 double-glass series	400	250	+5400/-2400
C78 single-glass series	450	250	+5400/-2400
C78 double-glass series	450	250	+5400/-2400
D60 single-glass series	400	160	+5400/-2400
D60 double-glass series	400	160	+5400/-2400
D66 single-glass series	430	160	+5400/-2400
D66 double-glass series	430	160	+5400/-2400
H48 single-glass series	200	200	+5400/-2400
H48 double-glass series	200	200	+5400/-2400
H54 double-glass series	305	100	+5400/-2400
H66 single-glass series	430	160	+5400/-2400
H66 double-glass series	430	160	+5400/-2400

Short frame clamp mounting (beam perpendicular to short frame)



Module type	S(mm)	Maximum test mechanical load (Pa)
C54 single-glass series	1/4short border length \pm 50	+5400/-1600
C54 double-glass series	1/4short border length \pm 50	+5400/-1600
C60 double-glass series	1/4short border length \pm 50	+5400/-1600
C72 single-glass series	1/4short border length \pm 50	+5400/-800
C72 double-glass series	1/4short border length \pm 50	+5400/-800
C78 single-glass series	/	/
C78 double-glass series	/	/
D60 single-glass series	/	/
D60 double-glass series	/	/
D66 single-glass series	/	/
D66 double-glass series	/	/
H48 single-glass series	1/4short border length \pm 50	+5400/-1600
H48 double-glass series	1/4short border length \pm 50	+5400/-1600
H54 double-glass series	1/4short border length \pm 50	+2400/-1000
H66 single-glass series	/	/
H66 double-glass series	/	/

Short bezel mounted on four corners



Module type	Maximum test mechanical load (Pa)
C54 single-glass series	+2400/-1600
C54 double-glass series	+2400/-1600
C60 double-glass series	+2400/-1600
C72 single-glass series	/
C72 double-glass series	/
C78 single-glass series	/
C78 double-glass series	/
D60 single-glass series	/
D60 double-glass series	/
D66 single-glass series	/
D66 double-glass series	/
H48 single-glass series	+2400/-1600
H48 double-glass series	+2400/-1600
H54 double-glass series	/
H66 single-glass series	/
H66 double-glass series	/

Long frame clamp mounting (beam parallel to long frame)

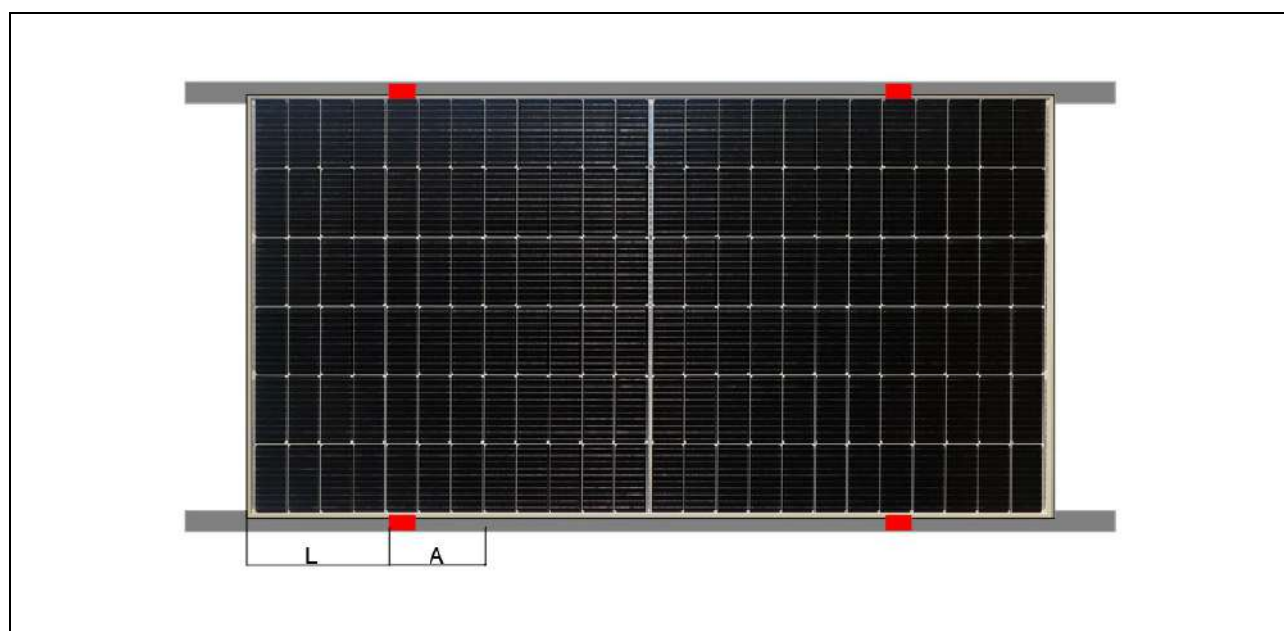

Module type	L(mm)	A(mm)	Maximum test mechanical load (Pa)
C54 single-glass series	200	100	+4000/-2400
	300	300	+3200/-2400
C54 double-glass series	200	100	+4000/-2400
	300	300	+3200/-2400
C60 double-glass series	/	/	/
C72 single-glass series	400	150	+3600/-2400
C72 double-glass series	400	150	+3600/-2400
C78 single-glass series	/	/	/
C78 double-glass series	/	/	/
D60 single-glass series	400	100	+2800/-2400
D60 double-glass series	400	100	+2800/-2400
D66 single-glass series	400	150	+3600/-2400
D66 double-glass series	400	150	+3600/-2400
H48 single-glass series	200	100	+4000/-2400
	300	300	+3200/-2400
H48 double-glass series	200	100	+4000/-2400
	300	300	+3200/-2400
H54 double-glass series	400	150	+3200/-2400
H66 single-glass series	400	150	+3600/-2400
H66 double-glass series	400	150	+3600/-2400

Short frame clamp mounting (beam parallel to short frame)

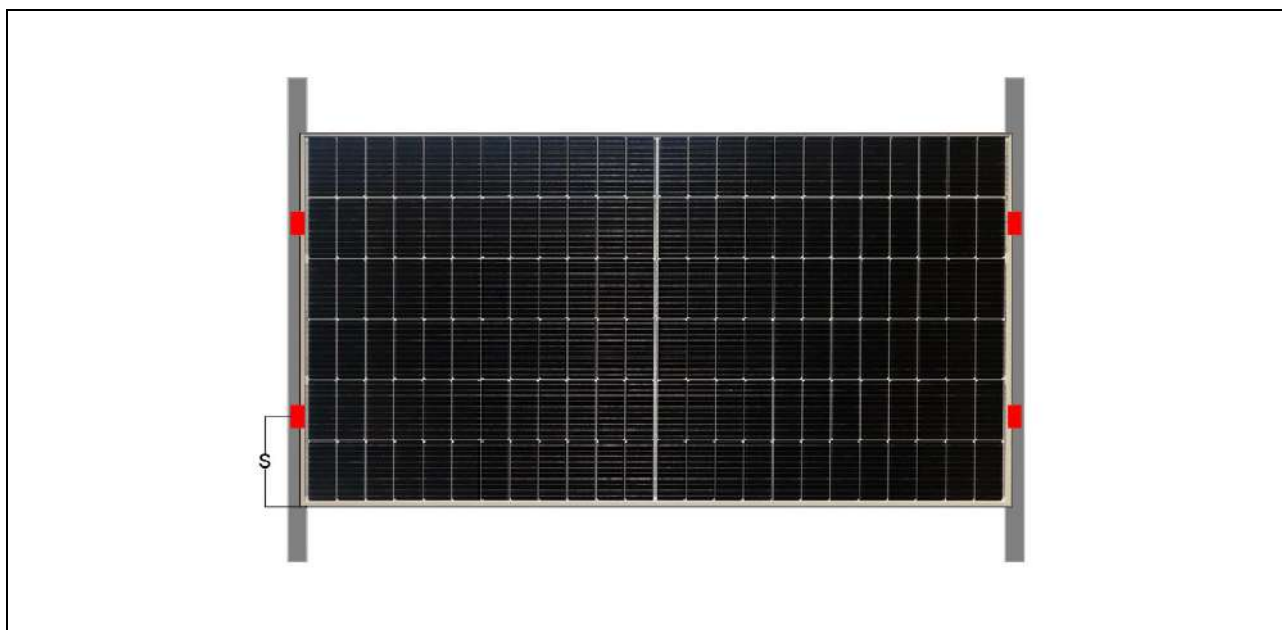

Module type	S(mm)	Maximum test mechanical load (Pa)
C54 single-glass series	1/4short border length \pm 50	+1600/-1600
C54 double-glass series	1/4short border length \pm 50	+1600/-1600
C60 double-glass series	/	/
C72 single-glass series	/	/
C72 double-glass series	/	/
C78 single-glass series	/	/
C78 double-glass series	/	/
D60 single-glass series	/	/
D60 double-glass series	/	/
D66 single-glass series	/	/
D66 double-glass series	/	/
H48 single-glass series	/	/
H48 double-glass series	/	/
H54 double-glass series	1/4short border length \pm 50	+1300/-1000
H66 single-glass series	/	/
H66 double-glass series	/	/

Six-press block mounting with beam

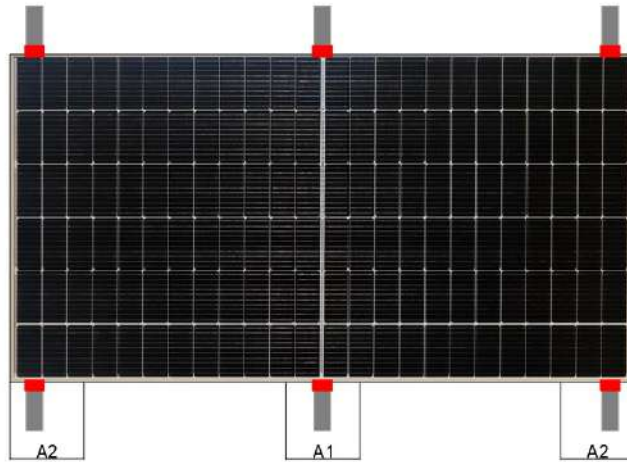

Module type	A1(mm)	A2(mm)	Maximum test mechanical load (Pa)
C54 single-glass series	100	80-380	+5400/-2400
C54 double-glass series	100	80-380	+6000/-3800
C60 double-glass series	/	/	/
C72 single-glass series	100	300-500	+5400/-2400
C72 double-glass series	100	300-500	+5400/-2400
C78 single-glass series	/	/	/
C78 double-glass series	/	/	/
D60 single-glass series	100	500-600	+5400/-2400
D60 double-glass series	100	500-600	+5400/-2400
D66 single-glass series	100	550-650	+5400/-2400
D66 double-glass series	100	550-650	+5400/-2400
H48 single-glass series	100	80-380	+5400/-2400
H48 double-glass series	100	80-380	+5400/-2400
H54 double-glass series	/	/	/
H66 single-glass series	100	550-650	+5400/-2400
H66 double-glass series	100	550-650	+5400/-2400

Six-press block mounting with beam

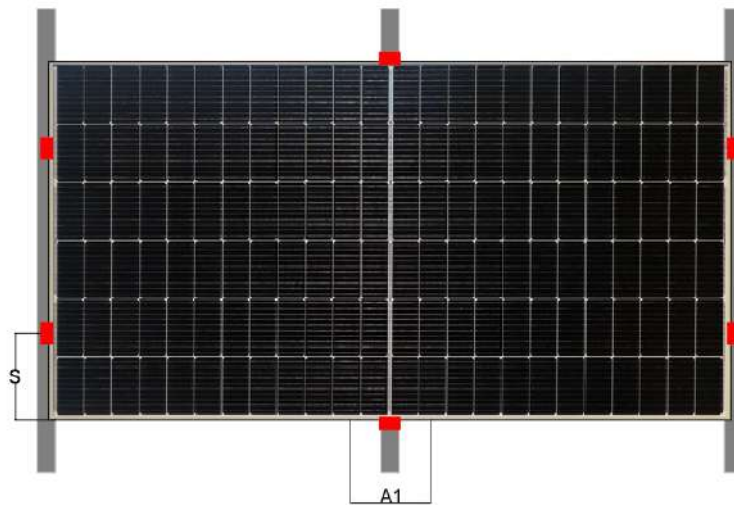

Module type	S(mm)	A1(mm)	Maximum test mechanical load (Pa)
C54 single-glass series	1/4short border length \pm 50	100	+5400/-3800
C54 double-glass series	1/4short border length \pm 50	100	+5400/-3800
C60 double-glass series	1/4short border length \pm 50	100	+5400/-2400
C72 single-glass series	1/4short border length \pm 50	100	+5400/-2400
C72 double-glass series	1/4short border length \pm 50	100	+5400/-2400
C78 single-glass series	/	/	/
C78 double-glass series	/	/	/
D60 single-glass series	/	/	/
D60 double-glass series	/	/	/
D66 single-glass series	/	/	/
D66 double-glass series	/	/	/
H48 single-glass series	1/4short border length \pm 50	100	+5400/-2400
H48 double-glass series	1/4short border length \pm 50	100	+5400/-2400
H54 double-glass series	/	/	/
H66 single-glass series	/	/	/
H66 double-glass series	/	/	/

Four press block mixed mounting with beam

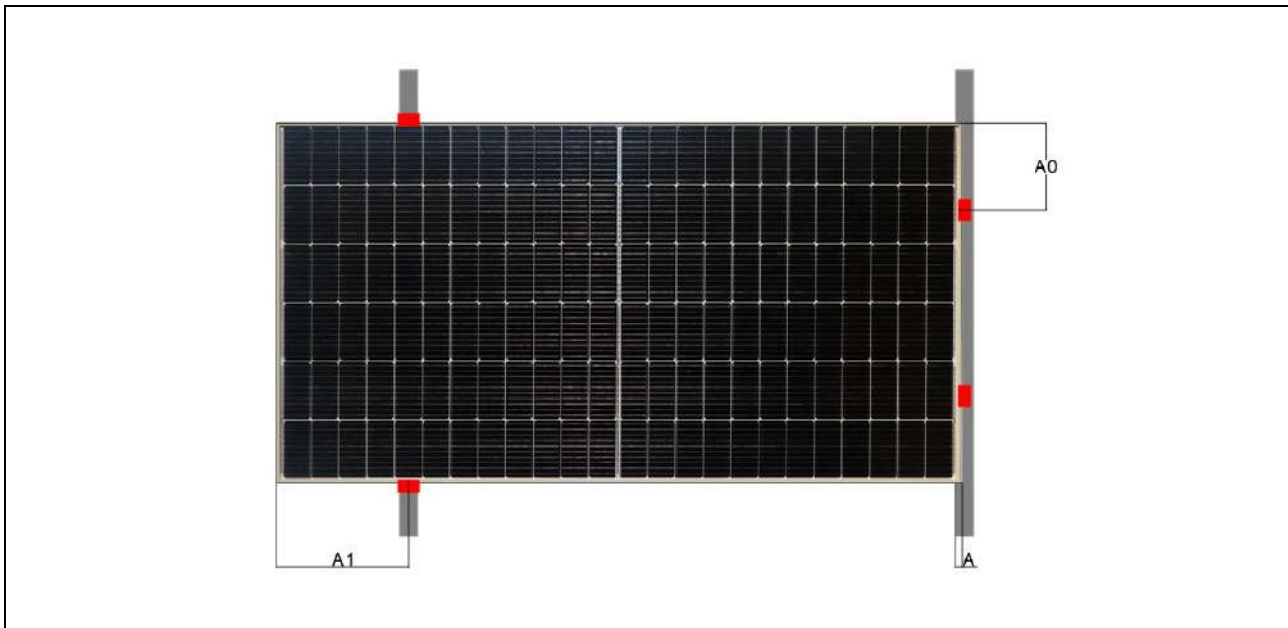

Module type	A(mm)	A0(mm)	A1(mm)	Maximum test mechanical load (Pa)
C54 single-glass series	≥ 40	1/4short border length ± 50	280-420	+2400/-2400
C54 double-glass series	≥ 40	1/4short border length ± 50	280-420	+2400/-2400
C60 double-glass series	/	/	/	/
C72 single-glass series	≥ 40	1/4short border length ± 50	600-800	+2400/-2000
C72 double-glass series	≥ 40	1/4short border length ± 50	600-800	+2400/-2000
C78 single-glass series	/	/	/	/
C78 double-glass series	/	/	/	/
D60 single-glass series	/	/	/	/
D60 double-glass series	/	/	/	/
D66 single-glass series	/	/	/	/
D66 double-glass series	/	/	/	/
H48 single-glass series	≥ 40	1/4short border length ± 50	320-460	+2400/-2400
H48 double-glass series	≥ 40	1/4short border length ± 50	320-460	+2400/-2400
H54 double-glass series	/	/	/	/
H66 single-glass series	/	/	/	/
H66 double-glass series	/	/	/	/

Tracking bracket mounting

Note: The loading values listed below are based on Suntech's internal assessment.

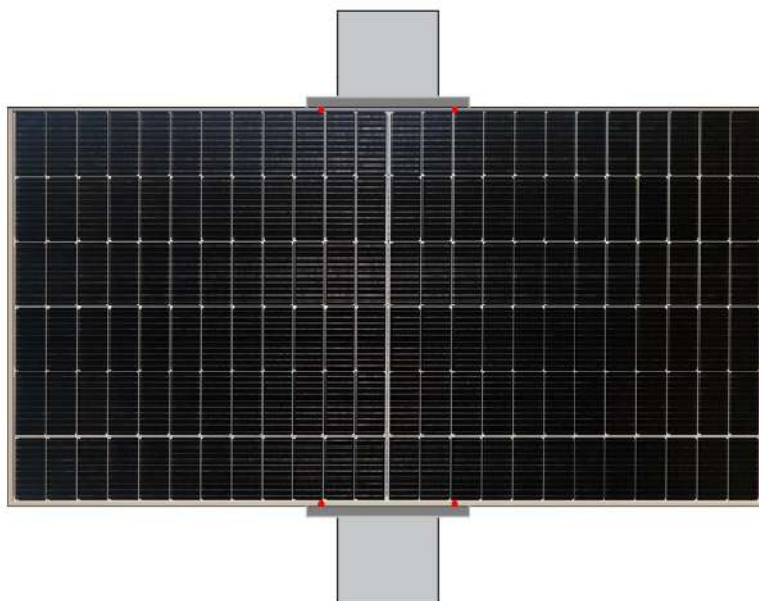

The rotating shaft is perpendicular to the long side, and the installation holes of the long frame are inner four holes (400mm holes) and middle four holes (790mm holes).

Type	Hole spacing	Inner four Holes (Pa)	Middle four holes (Pa)
C72 single-glass series		/	/
C72 double-glass series		+2400/-2400	+3260/-2400
C78 single-glass series		/	/
C78 double-glass series		+2400/-2400	+3000/-2400
D60 single-glass series		+2200/-2200	/
D60 double-glass series		+2200/-2200	/
D66 single-glass series		+2200/-2200	/
D66 double-glass series		+2200/-2200	+2800/-2400
H66 single-glass series		/	/
H66 double-glass series		+1800/-1800	+3200/-2400

The tracking support is installed vertically with double rows of bolts

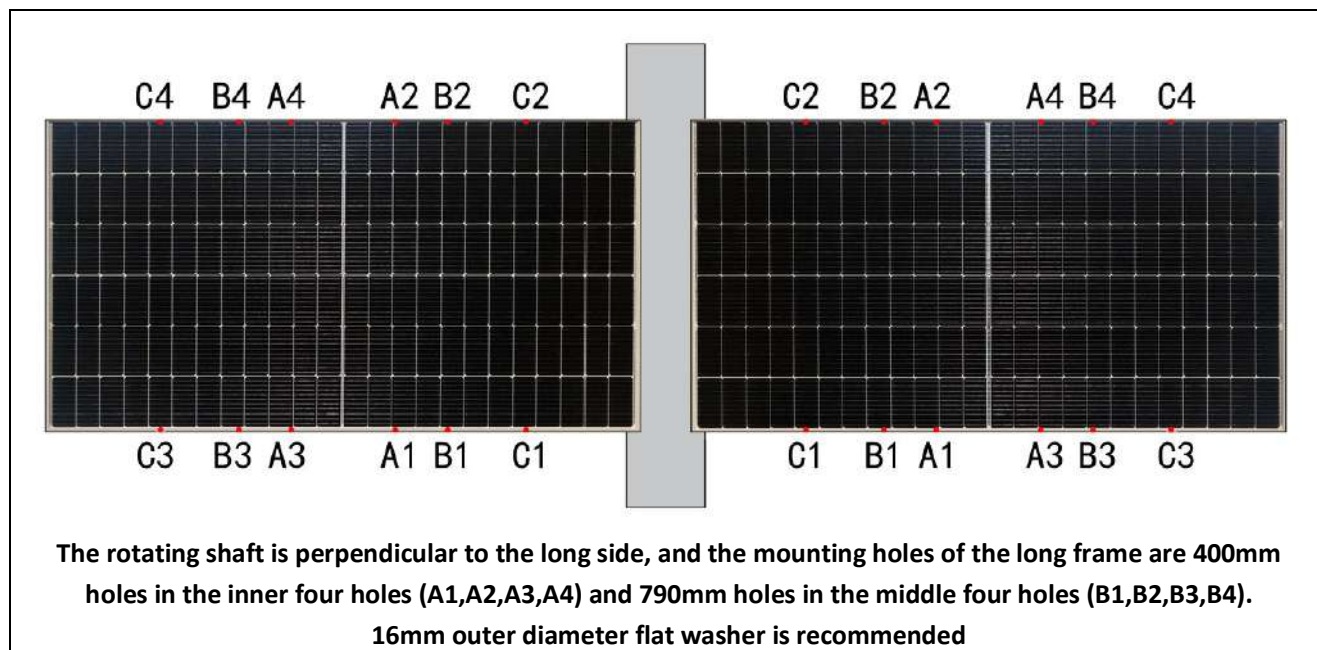

Module type	Location of mounting holes	Test Load (Pa)
C72 double-glass series	B1,B2,A3,A4	+1900/-1900
	B1,B2,B3,B4	+2600/-2200
C78 double-glass series	/	/
D60 double-glass series	B1,B2,A3,A4	+1800/-1600
	B1,B2,B3,B4	+2000/-1800
D66 double-glass series	B1,B2,A3,A4	+1800/-1600
	B1,B2,B3,B4	+2000/-1800

* The above load values are based on the static load requirements in the IEC61215 standard (Suntech or third party certification body test).

** In any case, the module clamp must not touch the front glass or deform the bracket to avoid blocking the battery by the module clamp and chute. The clamp cannot seal or cover the drain hole on the assembly bracket.

*** The mounting holes are reserved for the tracker single-axis mounting bracket. If the module is longer than 2 meters, the installation load value needs to be calculated separately.

Electrical Installation

Conventional Installation

Any mounting accessories used must be material compatible with each other to avoid electrochemical corrosion. Failure due to corrosion will void the warranty.

It is not recommended to use modules with different configurations in the same system.

Excess cables must be organized or adequately secured, for example, by using non-metal tie wires to secure them to brackets. Module cables, connectors and junction boxes should not be exposed to water, rain or snow or immersed in water for extended periods of time (IP65/67/68).

For applications requiring high operating voltages, multiple modules can be connected in series to form a module string; The system voltage is equal to the sum of the voltages of each module.

For applications requiring high operating currents, multiple modules can be connected in parallel; The system current is equal to the sum of the current of each module string.

According to the standard, the maximum system voltage of the module is 600 volts or 1000 volts or 1500 volts.

$$\text{Maximum system voltage} \geq N * \text{Voc} * [1 + \beta * (\text{Tmin} - 25)]$$

Where:

N —— number of modules connected in series

Voc —— open circuit voltage of each module (refer to product nameplate or specification) [V]

β —— thermal coefficient of open circuit voltage for the module (refer to the specification) [$^{\circ}\text{C}^{-1}$]

Tmin —— lowest ambient temperature [$^{\circ}\text{C}$]

Each PV module is equipped with bypass diodes to prevent hot-spot damage.

Manufacturer	Type	Ratings
Yangzhou Yangjie	30SQ045-SL	22 A, Tj 200°C
PanJit	30SQ045-SL	22 A, Tj 200°C
	40SQ045-SL	25 A, Tj 220°C
Jiangsu Tonglin	PT001B-22	22 A, Tj 200°C
	PT001B-25	25 A, Tj 200°C
	PT001B-30	30 A, Tj 200°C
Changzhou Starsea	30SQ045-SL	22 A, Tj 200°C
Wuxi Suntech Power Co., Ltd.	STP-3050	20 A, Tj 200°C
	STP-4050	25 A, Tj 200°C
	STP-5050	30 A, Tj 200°C
	STP-J-3050	20 A, Tj 200°C
	STP-J-4050	30 A, Tj 200°C
	STP-J-5050	30 A, Tj 200°C
Zerun Co., Ltd.	30SQ045	20 A, 22 A, Tj 200°C
	35SQ045	25 A, 27 A, Tj 200°C
	40SQ045	30 A, 32 A, Tj 200°C
	40SQ045B	30 A, 32 A, Tj 200°C
	30SQ045B	25 A, 27 A, Tj 200°C
	30SQ045C	25 A, 27 A, Tj 200°C
	38SQ045	25 A, Tj 200°C
	35SQ045C	25 A, 27 A, Tj 200°C
	4545W	35 A, Tj 200°C
	4545S	35 A, Tj 200°C
	Suzhou Xtong Photovoltaic	XT3050M-B

Technologies Co., Ltd.	XT4050M-B	25 A, Tj 200°C
	XT4550M-B	30 A, Tj 200°C
	XT5050M-B	35 A, Tj 200°C
Hongyuan Green Energy Co., Ltd.	HYM4045	25 A, Tj 200°C
	HYM5045B	30 A, Tj 200°C
	HYM6045	35 A, Tj 200°C

The bypass diodes are pre-installed in the junction box. Do not attempt to open, modify or replace the diodes without authorization, as this will void the product warranty.

The maximum number of modules connected in series is determined by the system design, the type of inverter used, and environmental conditions.

According to the maximum series fuse rating of the modules and local electrical installation specifications, if Suntech PV modules are connected in parallel, appropriate series fuses need to be assembled.

There is no special limit on the number of modules connected in parallel; the number of modules is determined by system design parameters such as current or power output.

To prevent cables and connectors from overheating, cables and connectors suitable for the maximum short-circuit current of the system must be selected. The recommended cable is a photovoltaic cable with a cross-section of at least 4mm².

- Conductor Material: Tinned Copper wire (the purity of copper 99.96%), Class 5 of IEC60228
- Insulation Material: Halogen free crosslinked polyolefin DS-J125XPVW/B-HV, ZF-JX001
- Temperature Rating: -40°C to +90°C (conductor operating temperature)
- Compliance: IEC 62930:2017

The bending radius of the cable shall not be less than 68mm as recommended by the cable manufacturer. All cables shall be selected to withstand the maximum short-circuit current of the system to prevent overheating. Do not place excessive pressure on the cable. Any damage caused by cable connection is not covered by Suntech's warranty.

Please refer to local regulations to determine the wiring size, type and temperature of the system.

Suntech modules are supplied with connectors for the electrical connection of the system. Recommended connectors:

Manufacturer	Type
Wuxi Suntech Power Co., Ltd.	STP-XC4-4
	STP-XC4-6
Stäubli (MC)	PV-KST4-EVO2/xy_UR, PV-KBT4- EVO2/xy_UR
	PV-KST4-EVO2A/xy, PV-KBT4- EVO2A/xy
	PV-KST4-EVO2/XY, PV-KBT4- EVO2/XY

Suntech strongly recommends the use of genuine connectors of the type specified in the Suntech product data sheet.

To ensure a reliable electrical connection and prevent possible entry of moisture, when the two connectors are interfacing, they must be locked until a click is heard.

Long-term exposure to moisture can lead to poor connector connectivity, resulting in leakage and poor conductivity, which will void the warranty. Suntech recommends proper management of connectors/cables/wiring to prevent moisture from entering. Depending on the severity of the moisture, Suntech recommends regular inspection of the installation system to ensure the good performance of the modules.

The direct current generated by photovoltaic systems can be converted into alternating current and used in the public power grid. As regional agencies vary in their policies for connecting renewable energy systems to the grid, always consult a qualified system designer or integrator for advice. Installation permits and inspection and approval by local authorities are usually required.

For larger installations, Suntech recommends lightning protection that meets local requirements and

regulations.

When the installation is complete and connected to the grid, prepare a professional document to hand to the owner, including the required installation agreement. At the same time, provide the owner with a clear system documentation, including at least the following information: user guide, system configuration, data sheets, performance expectations, electrical system data (such as a copy of the installation test report that meets the minimum requirements of IEC 62446 / IEC 60364-6).

When a large number of displays are connected to a single inverter, it is necessary to consider the reduction of insulation resistance caused by the increase of displays.

Suntech modules recommended connection methods:

Vertical single-row installation

The head and tail directions of the modules in the square array are in a cross arrangement, and the line length of the modules: the positive and negative line length meets the requirements for vertical assembly of the modules.

Series connection:

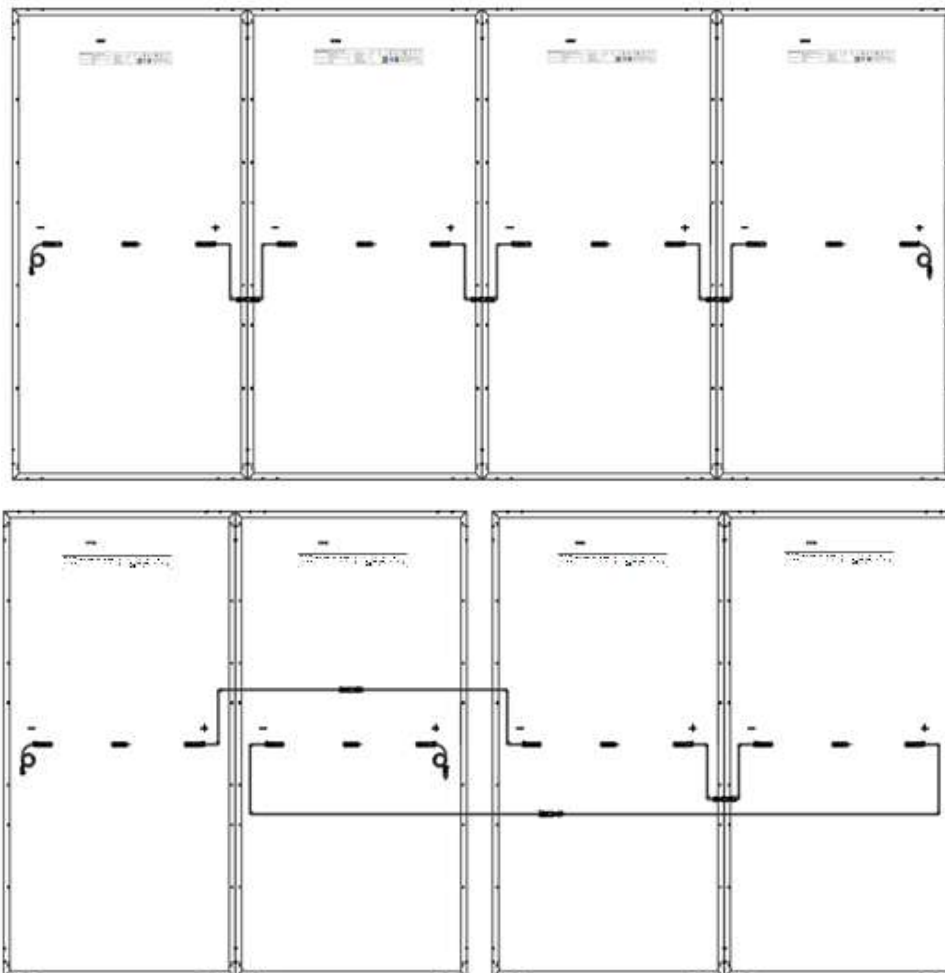

Parallel connection:

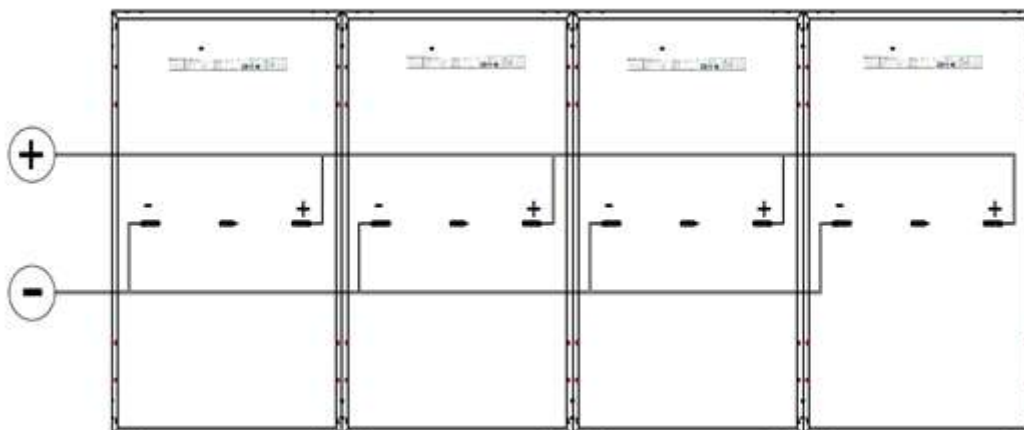

Vertical double-row installation

Conventional installation: Series connection

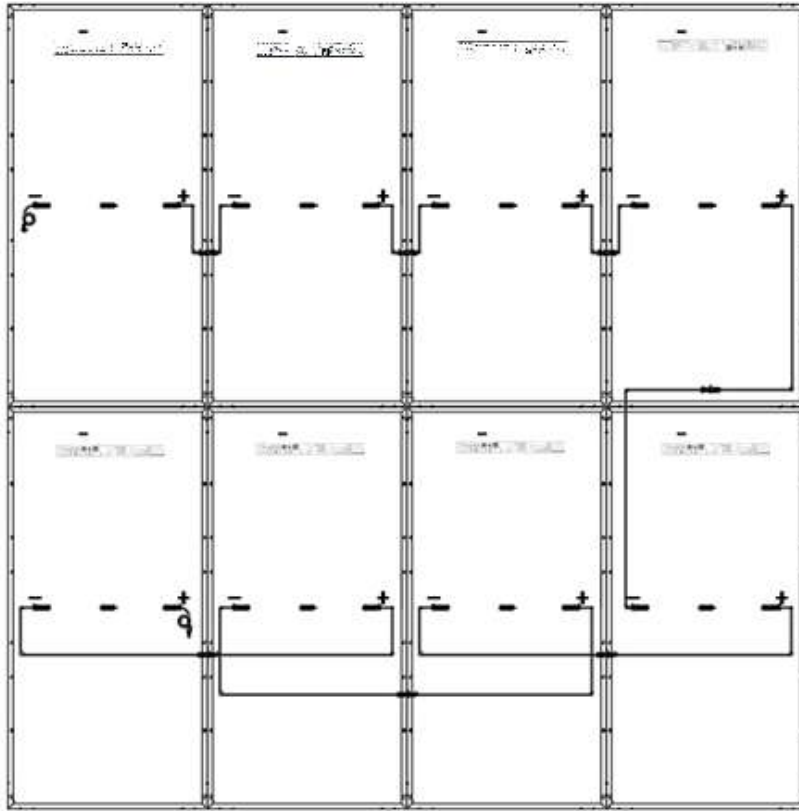

Modules in adjacent rows are flipped 180° to install: Series connection

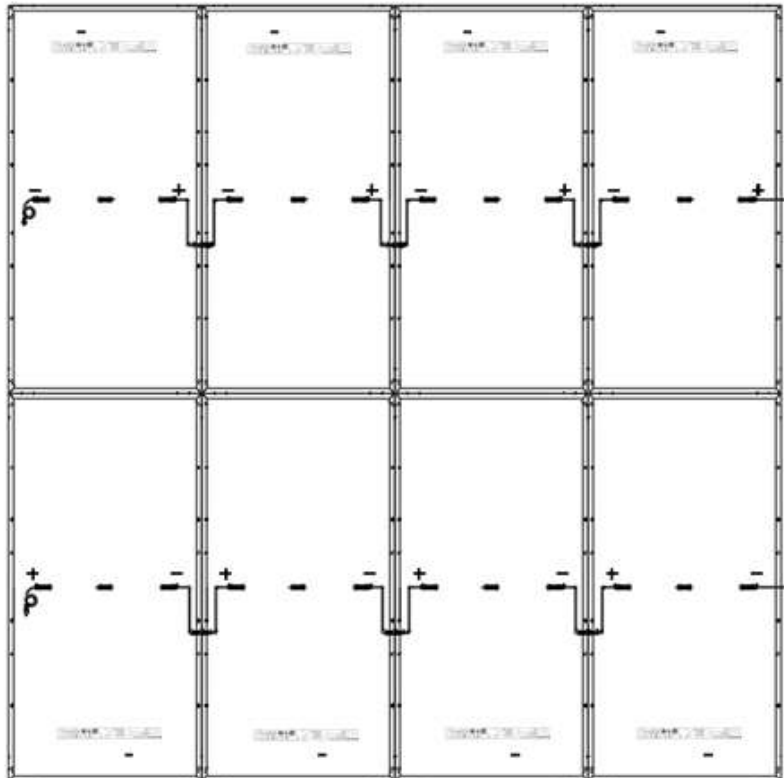

Parallel connection:

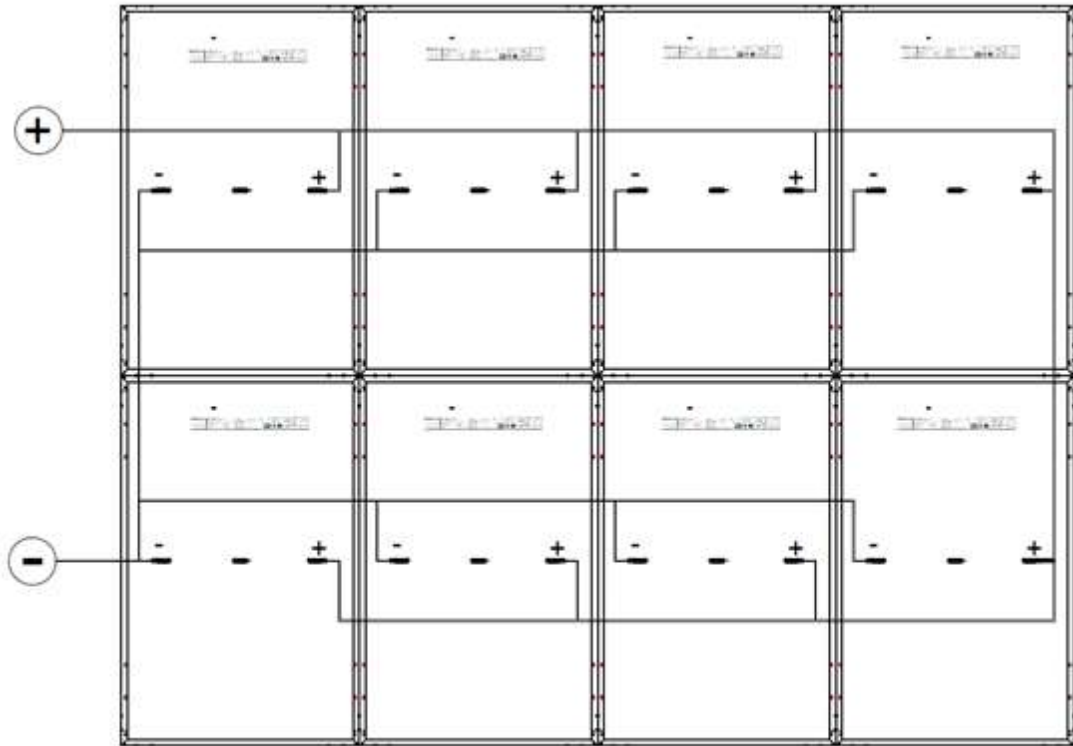

Series connection followed by parallel installation:

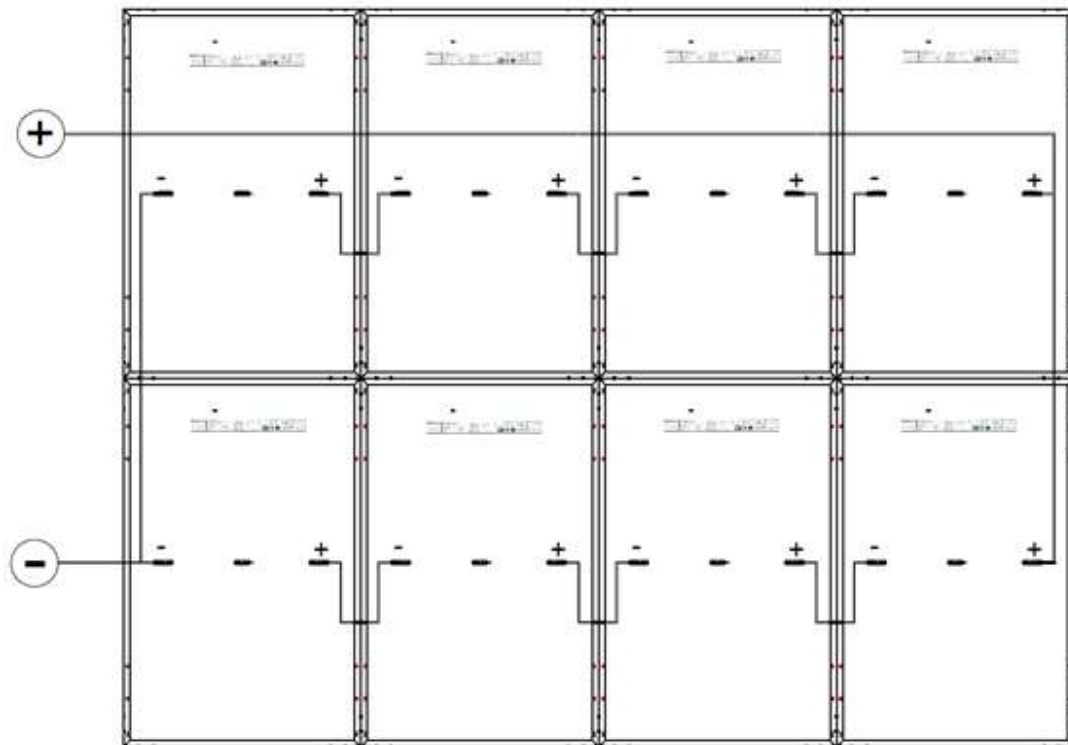

Installation in two horizontal rows

Conventional installation: Series connection

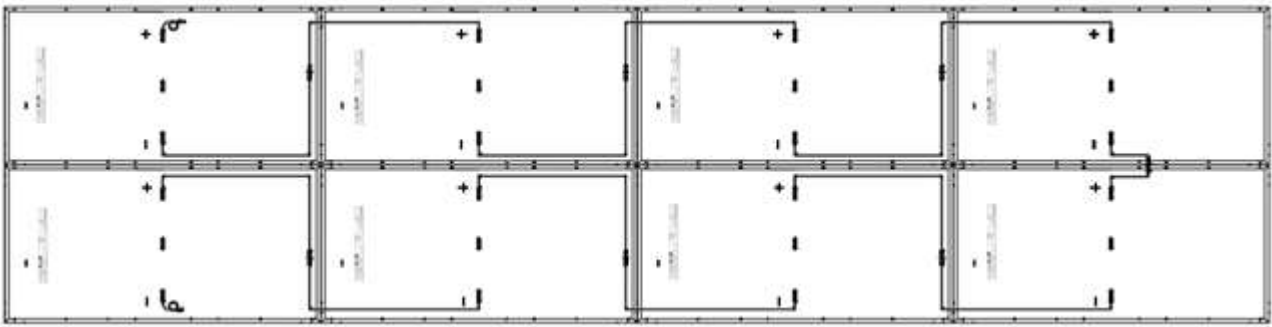

Modules in adjacent columns are flipped 180° to install: Series connection

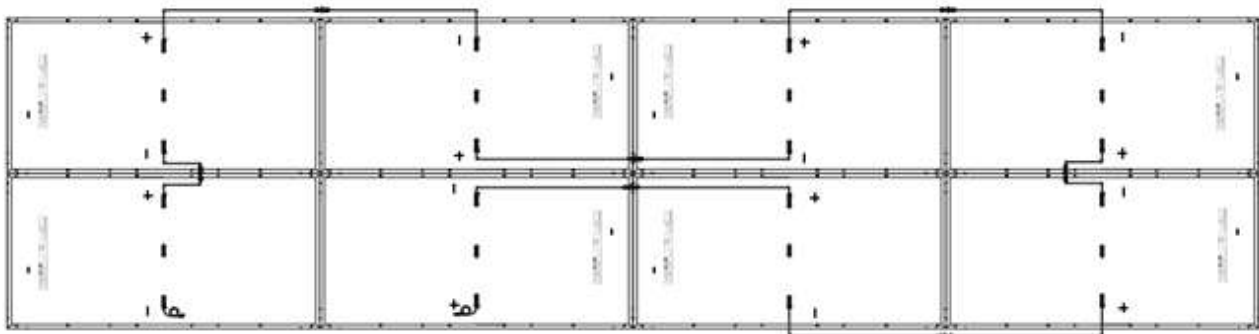

Parallel connection:

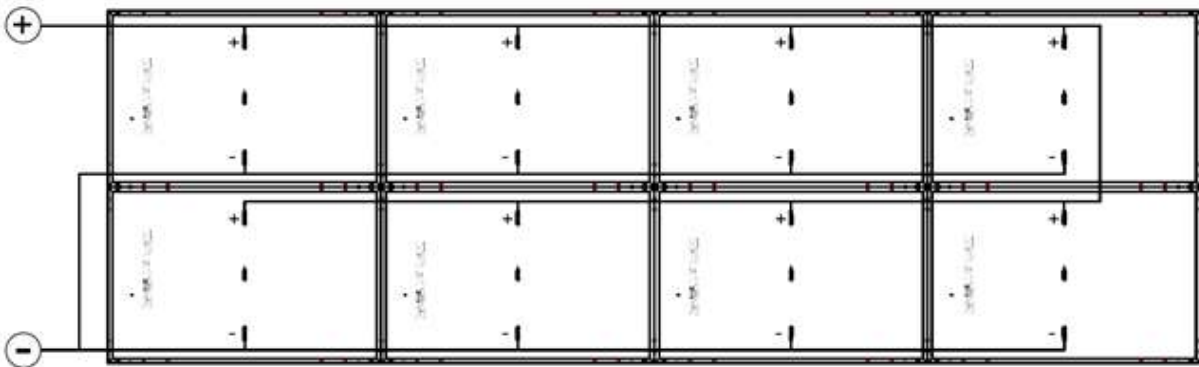

Series connection followed by parallel installation:

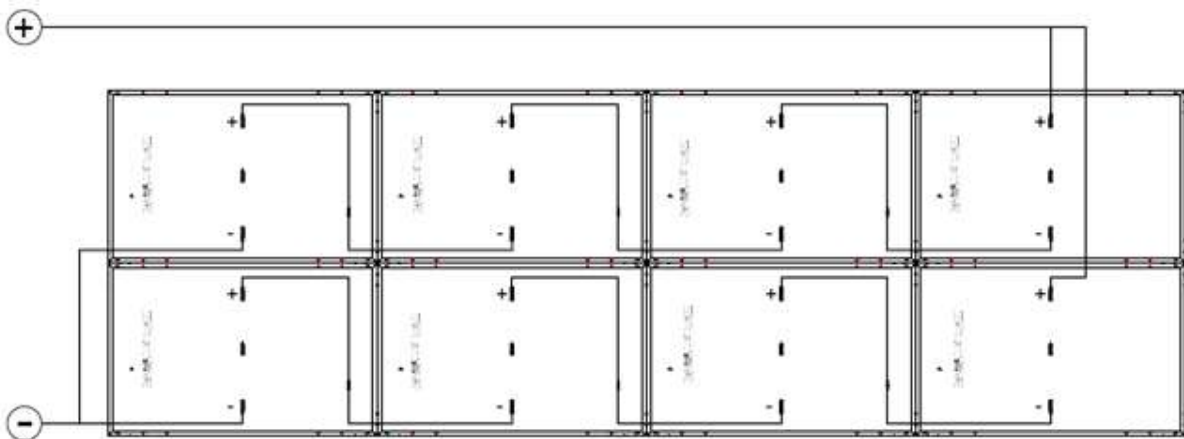

Allow modules in series to increase voltage or in parallel to increase current. In series, the positive electrode of the assembly is connected to the next negative electrode. In parallel, the positive electrode of a module is connected to the positive electrode of the next module.

Up to two strings of modules may be connected in parallel if overcurrent protection devices (fuses) are not used in series within each string of modules. Three or more strings of modules may be connected in parallel if an appropriate certified overcurrent protection device is connected in series to each string of modules. The photovoltaic system design must ensure that the reverse current of each string of modules is in all cases less than the maximum fuse current of the module.

To avoid (or reduce) the mismatch effect of arrays, it is recommended that modules with similar electrical properties be connected on the same string.

Ground Connection

To ensure safety and protect modules from lightning strikes and static electricity, ensure that the module frame is grounded.

Suntech recommends always referring to local and national codes and requirements for grounding photovoltaic modules. If local authorities allow it, Suntech strongly recommends using negative grounding.

The support grounding hardware and wiring must be installed to the appropriate grounding mark on the support to ensure proper electrical connections.

There is a ground hole with a diameter of approximately 4mm at both ends of the back frame of the module. The ground hole on the frame is identified by the typical ground symbol (\perp) according to the IEC61730-1 standard. It can only be used for grounding, not for module installation.

The grounding connection should be performed by qualified electricians, and the grounding device must be made by a qualified electrical manufacturer. All conductive connection points with the PV module frame need to penetrate the insulation layer to ensure reliable grounding.

Do not add any additional ground holes to the assembly frame.

Suntech recommends grounding resistance $< 1\Omega$.

Use a 4 mm² copper core wire to ground modules. Place the star washer, flat washer, and ground cable one by one, thread a screw through the ground hole, and then tighten the screw to connect the adjacent ground holes on the module frame. The modules can also be grounded safely.

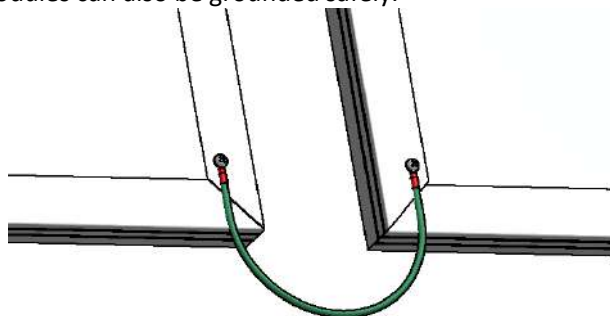

Suntech recommends the following grounding methods:

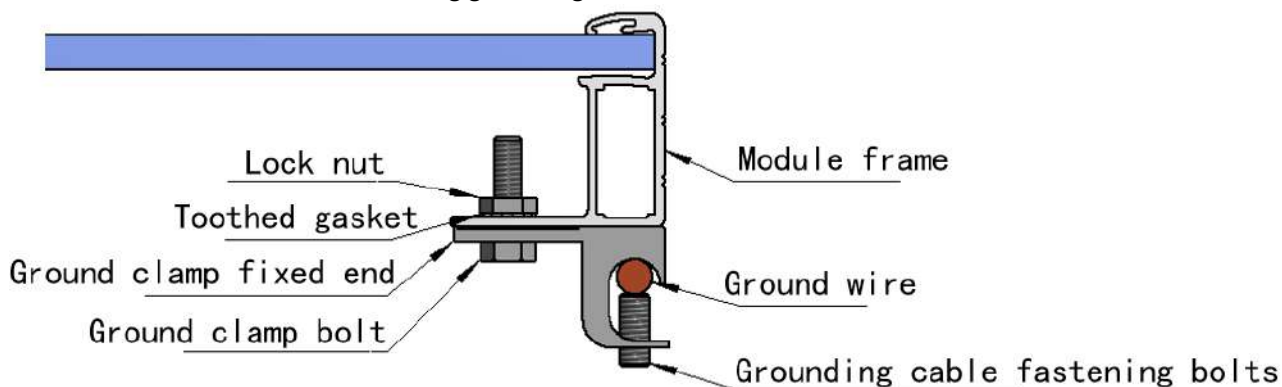

As shown in the diagram above, connect the copper conductor to the grounding hole on the module frame using the grounding components (M5 stainless steel cover bolt, M5 stainless steel flat washer, M5 stainless steel cup washer, and M5 stainless steel serrated nut).

Position the conductor between the flat washer and the cup washer. Ensure that the cup washer is placed between the frame and the conductor, with the concave side facing upwards to prevent galvanic corrosion. Securely tighten the bolt with the stainless steel serrated nut. A torque wrench may be required during installation. The tightening torque for the nut is 3 N·m to 7 N·m. For more details, refer to the Suntech module product drawings.

The nuts and washers are made of stainless steel. The material and size of the ground cable should meet the requirements of the local national, regional or international regulations, laws and standards. 4 to 14 mm² (AWG6-12) exposed copper cable is recommended.

Suntech PV modules can be grounded using a third-party grounding device, but the grounding must be proven reliable.

Maintenance

Please be sure to check and maintain the modules regularly, especially during the warranty period, which is the user's responsibility, and notify Suntech customer service within two weeks if the modules are found to be damaged or other significant anomalies.

Visual Inspection

Please carefully check the modules for appearance defects, focusing on the following points:

1. Whether the module glass breaks
2. Check whether the backplane of the module has burn marks
- 3, whether there are sharp objects contact the surface of the module
4. Whether the module is blocked by obstacles or foreign bodies
5. Check whether the fixing screws between the modules and the support are loose, damaged or corroded, and adjust or repair them in time

Note: Due to the use of anti-reflection coating technology on the surface of the photovoltaic module, if the color difference is found in the module at different angles, this is a normal phenomenon. If the color difference exists within the battery, contact customer service for further analysis.

Cleaning

The power generation of photovoltaic modules is related to the solar radiation received by their cells. Dirt blocking the glass surface of the module will reduce its power output and may even cause regional heat spots, so it is important to keep the surface of the module clean, usually need to clean the surface of the module dirt such as: bird droppings, leaves, ash layer, etc. Suntech recommends that modules be cleaned at least once a year, and modules installed in dusty environments or at low angles should be cleaned appropriately to ensure the cleanliness of the module surface. Uncontrolled contamination and failure to clean modules in a timely manner will void the warranty.

This section contains Suntech PV module cleaning requirements, system users and professional installers should carefully read and strictly follow. Failure to follow these instructions may result in personal injury or property damage. Suntech is not responsible for any damage caused by improper cleaning methods and will lose the limited warranty of the product.



Warning

Cleaning can cause damage to modules and a range of modules, as well as increasing the risk of electric shock.

Cracked or damaged modules pose a risk of electric shock due to leakage of current, and damp modules increase this risk. It is necessary to thoroughly inspect the modules for cracks, damage, and loose joints before cleaning.

During the day, the voltage and current present in the array is sufficient to cause a fatal electric shock accident, and the photovoltaic module should be cleaned under low irradiance conditions.

Before cleaning, make sure the circuit is disconnected.

Please wear suitable protective clothing (clothing, insulating gloves, insulating shoes, etc.) when cleaning.

Do not immerse the module in part or in whole in water or any kind of cleaning solution.

Generally, the back of the module does not need to be cleaned. If it is necessary to clean the back of the double-sided module, be careful to avoid damage to the back of the module. It is recommended to carefully clean the stain with your hand or sponge.

Please use the solvent specified by Suntech in the cleaning method.

Cleaning Method

1. High pressure water cleaning

Water quality requirements: PH6~8

Water hardness: calcium carbonate concentration $\leq 600\text{mg/L}$ (Soft water cleaning is recommended)

Water pressure: $\leq 4\text{MPa}(40\text{bar})$

2. Compressed air cleaning

Air pressure cleaning is recommended when cleaning soft stains (like dust) on modules.

3. Wash by hand

If there are too many stains on the surface of the module, carefully use an insulating brush, sponge, or other soft cleaning tool.

Make sure any brushes or agitating tools are made of insulating material to minimize the risk of electric shock, and that the tools do not scratch or scratch the glass or aluminum frame.

If oil stains are present, they can be carefully cleaned with an environmentally friendly cleaner.

4. Robot cleaning

If robot cleaning is used, the brush is required to be soft plastic, the cleaning process and cleaning will not cause scratches to the glass surface of the module and the aluminum alloy frame, the weight of the cleaning robot should not be too large, and the module damage caused by improper cleaning of the cleaning robot and power attenuation are not within the scope of Suntech warranty.

To ensure optimum module performance, Suntech recommends the following maintenance measures:

Inspect electrical, grounding, and mechanical connections every 6 months to ensure they are clean, safe, undamaged, and free of rust. Otherwise, the warranty will be void.

In the event of a ground fault, do not use water to clean or spray the modules until corrected by an authorized solar inverter service person and until the inverter is fully operational, which could result in a click accident or serious safety issue.

If you have any questions, please consult a professional solar service provider for advice.

Note: Please follow the solar manufacturer's maintenance instructions for all modules used in the system, such as brackets, charge regulators, inverters, batteries, etc.